

Modular 66 Cross Connect Blocks and Adapters

HUBBELL

Hubbell Premise Wiring

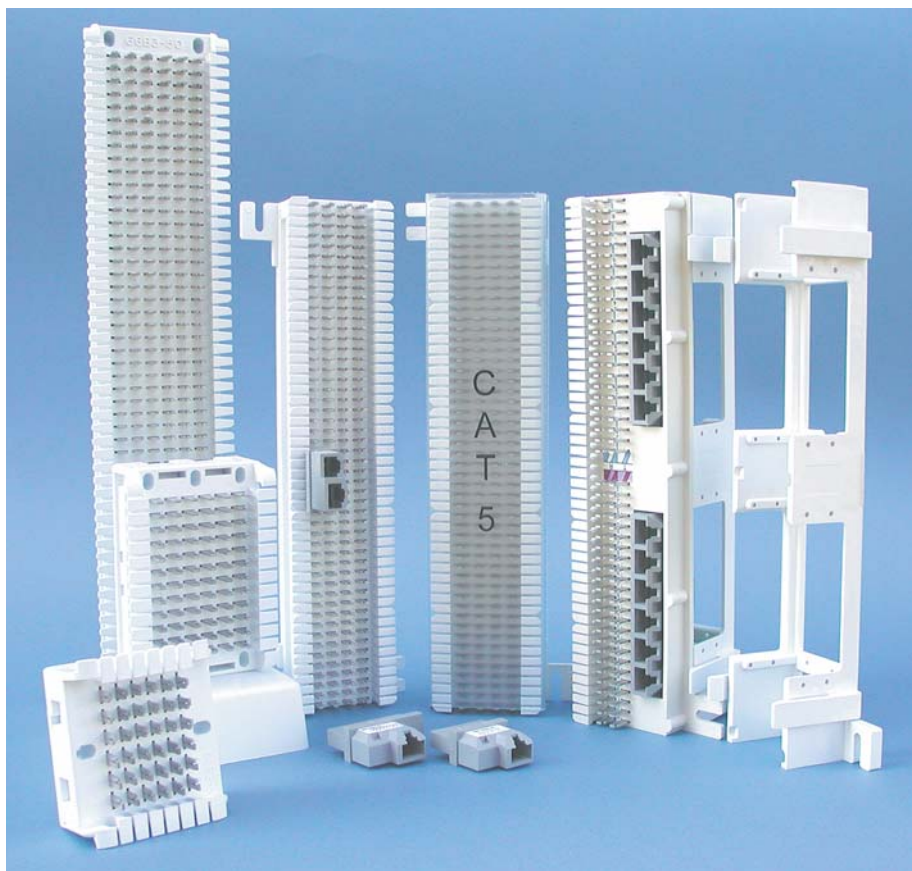

Hubbell Premise Wiring offers industry standard modular 66 blocks to add to its family of cross connect products. These blocks are used in equipment rooms and intermediate telecommunication closets to connect voice and data network wiring to customer premises equipment. Additionally, 66 blocks are used to expand Legacy systems or as a cost-effective, high-density, small scale cross connect for voice applications.

Hubbell's complete 66 block system not only includes popular B blocks and M blocks, but also a broad line of modular adapters to add modularity for quick adds, moves, and changes in the cross connect system without disturbing the horizontal station wiring.

Unshielded twisted pair wiring will perform in high-speed LAN applications characterized up to 100Mbps, when terminated to the **HPW66M150C5** according to the recommendations of EIA/TIA-568-A (rev.).

The **HPW66M150C5** block is equipped with a snap-on clear protective cover and consists of a molded block that contains 100 2-clip (50-pair) quick-connect terminals. All standard 66 line accessories and tools are compatible with the Category 5 connecting block.

SPECIFICATIONS

- Jack contacts are Beryllium copper with minimum 50 micro-inch gold plate, over 50 to 100 micro-inch nickel
- Modular jacks per FCC part 68.5
- Blocks molded of flame-retardant thermoplastic with quick-connect clips



PTS For More Information:
 (866) 787-3271
 Sales@PTSdcs.com

DATA CENTER SOLUTIONS

FEATURES	BENEFITS
■ Flexible	➤ Supports a diverse range of application requirements for voice and data
■ Complete solution	➤ Flexibility is enhanced with a complete system of block sizes, adapter configuration, and mounting and cable management accessories
■ Modular adapters	➤ Facilitates adds, moves, and changes in the cross connect
■ Category 5 performance	➤ Modular 66M blocks provide high performance to meet and exceed Category 5 TIA/EIA-568-A performance requirements to 100MHz
■ Ease of termination	➤ Quick connections are made possible with 66-clip connection terminals for easy, reliable termination

ORDERING INFORMATION - Modular 66 Blocks

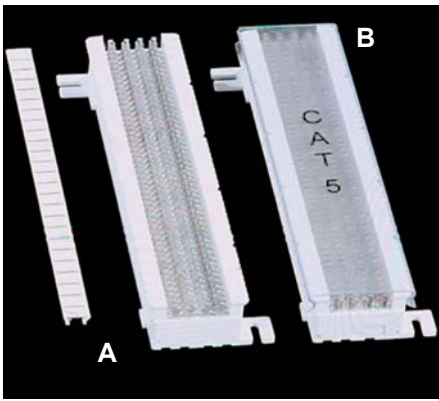

Modular 66M Block - Category 5 Connecting Blocks

The Category 5 66M series connecting blocks have been designed to offer increased flexibility of wiring arrangements and reduced costs where fewer distribution terminals are needed. Designed to meet Category 5 TIA/EIA-568-A performance to support high-speed data and wire systems.

Description	Capacity	Catalog No.
A Modular 66M Block	25-pair	HPW66M125
Modular 66M Block	50-pair	HPW66M150
B Modular 66M Block, Cat 5 w/Cover	50-pair	HPW66M150C5
Cover only		HPW66MCVR

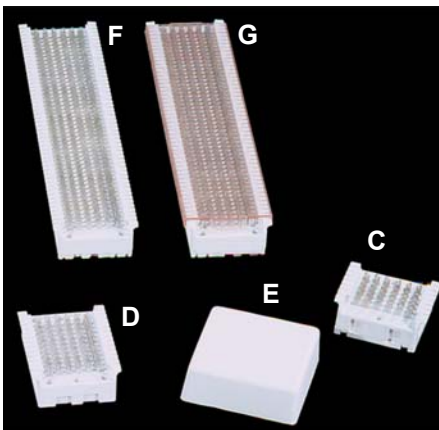

Modular 66B Block - 25- and 50-pair Connecting Blocks

The 66B series connecting blocks are designed for fast and easy termination of incoming building cables for key telephone installations. The smaller connecting blocks satisfy the need for a block smaller than the 25-pair size. Increased plant flexibility is offered, as they are easily stacked to provide 12, 18, 24, etc. pairs of terminals.

Description	Capacity	Catalog No.
C Modular 66B Block with Cover, Split (3x)	6-pair	HPW66B36
D Modular 66B Block	6-pair	HPW66B16
E Cover only	6-pair	HPW66BCVR
F Modular 66B Block	25-pair	HPW66B425
G Modular 66B Block	50-pair	HPW66B350



Modular 66 12-port Block

These 12-port blocks support installations not large enough to warrant a patch panel. All blocks are designed with printed circuit boards for consistent electrical performance. Category 5e and 3 performance verified and listed by UL.

Description	Wiring	Jack Openings	Capacity	Catalog No.
Modular 66 Block	T568B	12-8 pos. jacks	50-pair	BR258066A
Modular 66 Block	USOC-RJ25	16-6 pos. jacks	50-pair	BR256066A

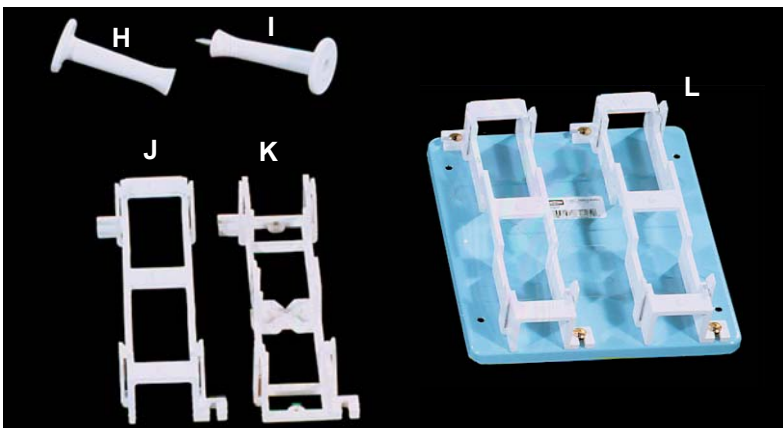
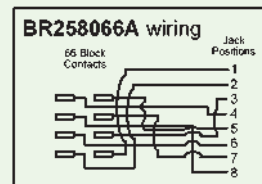
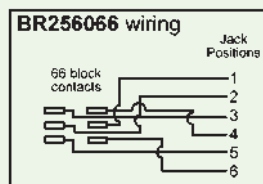

Accessories

The cable routing spools provide control and dressing of distribution cables and jumper wires. They are available with or without screws. The mounting brackets are molded of durable self-extinguishing thermoplastic. Mounting holes are provided for use in a variety of mounting options.

Description	Catalog No.
H Cable Routing Spool	HPW66SPLA
I Cable Routing Spool with screw	HPW66SPLB
J 89B Bracket	HPW89B
K 89D Bracket	HPW89D
L Backboard	HPW66BB

Modular 66 Adapters



Hubbell's 66 Block Adapters are available in 8-position RJ45 and 6-position RJ14 jack configurations. These adapters provide a user friendly modular interface for a 66M series block. The 66 Block Adapter's printed circuit board design provides superior performance in applications requiring the splitting of contacts.

SPECIFICATIONS

- UL 1863 Listed - File #E129878
- CSA Certified - File #LR80837
- UL 94V-0 rated thermoplastic
- Jack contacts are Beryllium copper with minimum 50 micro-inch gold plate, over 50 to 100 micro-inch nickel
- Modular jacks per FCC part 68.5

FEATURES	BENEFITS
■ Stackable design	➤ Allows access to 48 of the 50 positions on the block
■ Printed circuit board	➤ Superior performance and reliability
■ Ease of installation	➤ Simply snaps onto the 66 block clips for upgrading to modular field
■ Allows modular patching on a 66 block	➤ Plug-in and network capabilities/cost and labor savings

ORDERING INFORMATION - Modular 66 Adapters



Catalog Number **BR866JA**
The BR866JA modular 66 adapter provides a T568B, 8-position RJ45 jack connection to a 66M block, bridging pair 4 to a second 6-position jack for power source at the equipment closet.

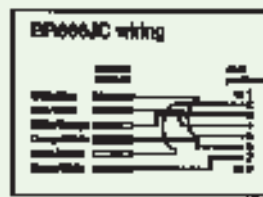

Catalog Number **BR666JC**
The BR666JC modular 66 adapter provides a modular connection between 6 consecutive block positions with an RJ25, USOC, 3-pair modular patch cord.

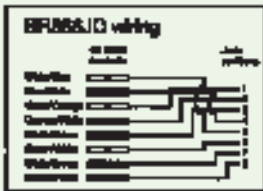

Catalog Number **BR866JC**
The BR866JC modular 66 adapter provides modular connection between a 66M block and a RJ45 modular patch cord by connecting 8 consecutive block positions to a T568B RJ45 jack.

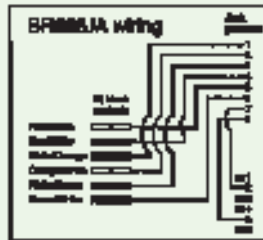

Catalog Number **BR666JA**
The BR666JA modular 66 adapter provides a modular connection between 6 consecutive block positions splitting pair 1, 2 & 3 to a T568B RJ45 jack. Pair 4 of the RJ45 jack is jumped to a 6-position jack for supplying power or ancillary circuits.

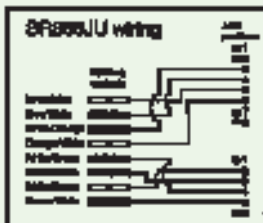

Catalog Number **BR866JU**
The BR866JU modular 66 adapter provides a modular connection between 8 block positions splitting pair 1 & 2 to an RJ45 jack, and pair 3 & 4 to a 6-position jack.

DIMENSIONS

Modular 66M Block

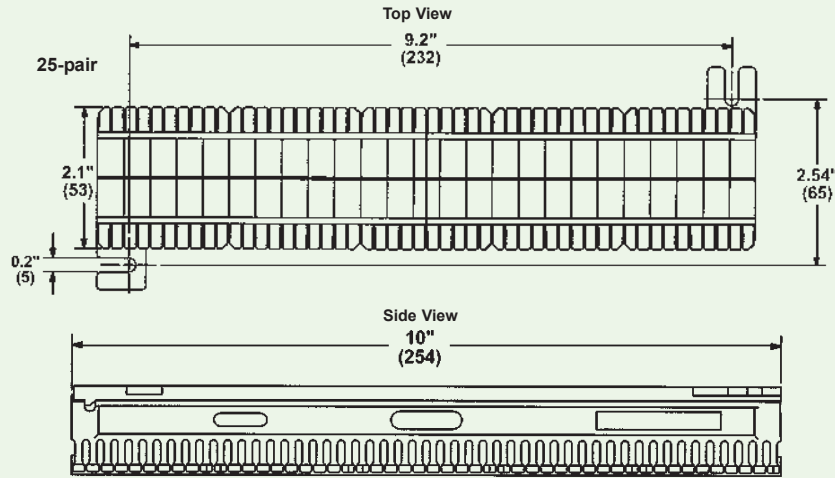

Modular 66B Block

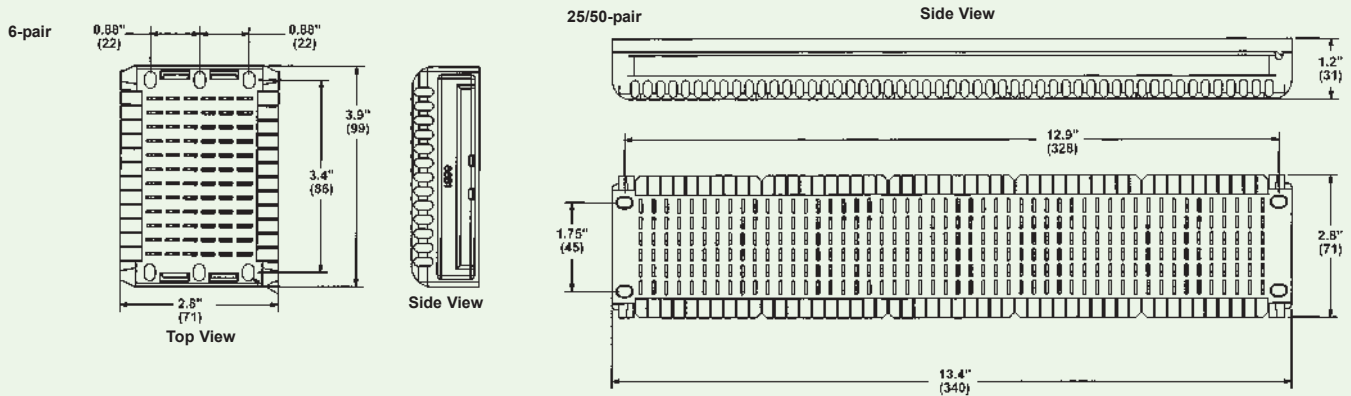

Modular 66 Adapters

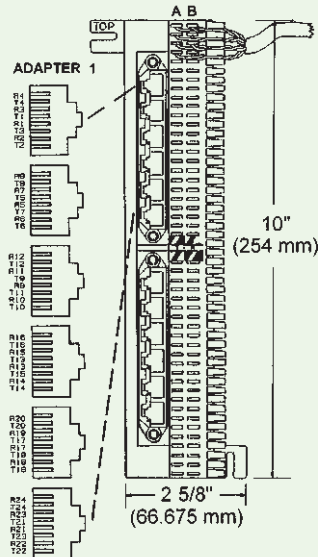

Modular 66 Contact Configurations

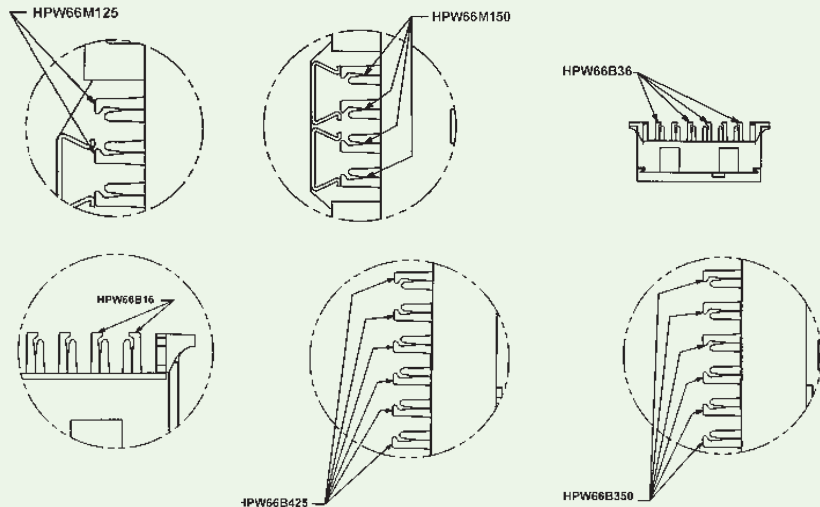

Hubbell Premise Wiring
 HUBBELL INCORPORATED (Delaware)
 14 Lord's Hill Road • Stonington, CT 06378-0901 • (860) 535-8326 • 800-626-0005
 Fax: (860) 535-8328 • Internet site: <http://www.hubbell-premise.com>

PTS For More Information:
 (866) 787-3271
 Sales@PTSDcs.com
 DATA CENTER SOLUTIONS

DS-C19 12/03

Worldwide Locations

Hubbell Premise Wiring, Asia Pacific	852-2836-7131	Fax: 852-2836-7132	Hubbell de Mexico, S.A. de C.V.	52-5-575-2022	Fax: 52-5-559-8626
Hubbell Canada Inc.	905-839-1138	Fax: 905-839-9108	Hubbell Premise Wiring, Middle East	971-4-393-4192	Fax: 971-4-393-4194
Hubbell Premise Wiring, China	86-21-6217-3478	Fax: 86-21-6217-3481	Hubbell Premise Wiring, Puerto Rico	787-460-3380	Fax: 787-751-7309
Hubbell Premise Wiring, Europe	44-(0)1234-848550	Fax: 44-(0)1234-856190	Hubbell-Taian Co., Ltd., Taiwan	886-2-(0)2515-0855	Fax: 886-2-(0)2515-0899
Hubbell Int'l. Inc., Korea Branch	82-2-(0)2607-1363	Fax: 82-2-(0)2603-7386	Hubbell Incorporated, Turkey	90-216-414-8147	Fax: 90-216-414-8148
Hubbell Premise Wiring, Latin America	305-476-1862	Fax: 305-323-6498	Hubbell Premise Wiring, Venezuela	58-81-820323	Fax: 58-81-820323